

Overview

Use this guide to connect an Automatic Identification System (with an RS-232 hardware interface) to your Humminbird® control head. We encourage you to read this guide completely so you may understand the connection requirements.

Compatible Units: This guide covers the connection information for the HELIX® Series. Specific model numbers are listed below:

- HELIX 5 G2 Series
- HELIX 7 G2 Series
- HELIX 7 G2N Series
- HELIX 9 Series
- HELIX 9 G2N Series
- HELIX 10 Series
- HELIX 10 G2N Series
- HELIX 12 Series
- HELIX 12 G2N Series

To connect an AIS to the ONIX® or ION®, visit our Web site at humminbird.com to download the appropriate guide.

Customer Service: If you have questions about the installation, visit our Web site at humminbird.com or call Humminbird Customer Service at **1-800-633-1468**.

1. Identify the Humminbird Port for AIS Connection

Identify the port you will use to connect the AIS to your Humminbird Control Head.

1. Using the illustrations on this page, locate the AIS-compatible port on your control head.

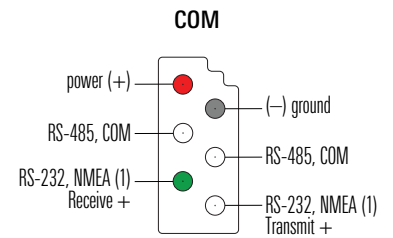
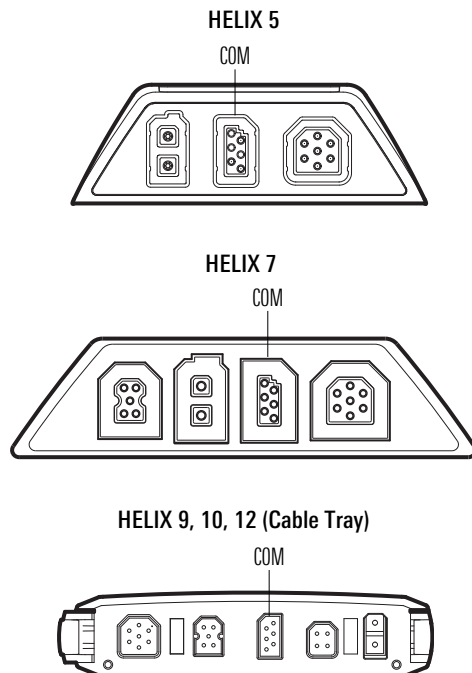

AIS Connection Guide

2. Connect the AIS to the Humminbird Control Head

The connection method is determined by the cable connector on the AIS data cable you have purchased.

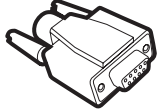

If the AIS data cable has a **DE-9 connector**, see *DE-9 Connection*.

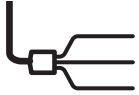

If the AIS data cable has **bare wires** for the connection, see *Bare Wire Connection*.

DE-9 Connection

If the AIS equipment includes a data cable with a DE-9 connector, use the instructions in this section.

Required Supplies (not included): Humminbird PC Connect Cable (AS-PC2), AIS data cable with a DE-9 connector, and a null modem adapter.

1. Turn off the power for the Humminbird control head and the AIS.
2. Connect the AS-PC2 NMEA-COM connector to the Humminbird COM port.



NOTE: If your control head uses a cable collector or cable tray, see your control head installation guide for details.

3. Connect the AS-PC2 cable's DE-9 connector (female) to the null modem.
4. See your AIS installation guide to connect the AIS data cable to the AIS.
5. Connect the AIS data cable's DE-9 connector to the null modem.

Connecting an AIS to the HELIX Series with a DE-9 Connection

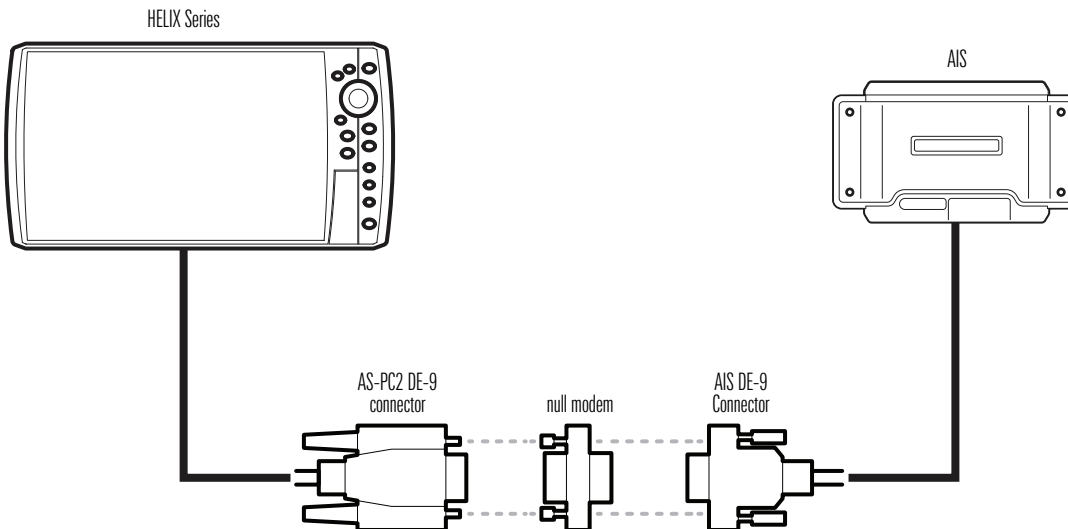

6. See your AIS installation guide to connect power to the AIS equipment and finish the installation.
7. Proceed to section 3 to set the baud rate.

AIS Connection Guide

Bare Wire Connection

If the AIS equipment includes a data cable with bare wires for connecting, use the instructions in this section.

Required Supplies (not included): Humminbird AS-HHGPS Cable, AIS data cable with bare wires (RS-232 or RS-422).

1. Turn off the power for the Humminbird control head and the AIS.
2. Use your AIS installation guide to locate the transmit, receive, and ground wires on the AIS data cable.
3. Connect the AS-HHGPS wires to the AIS data cable wires as shown in **Chart 1: RS-232 AS-HHGPS to RS-232 AIS**.

If your AIS data cable has a different set of wires, you can use one of the optional wiring charts shown on this page. See Chart 2, Chart 3, or Chart 4.

Chart 1: RS-232 AS-HHGPS to RS-232 AIS

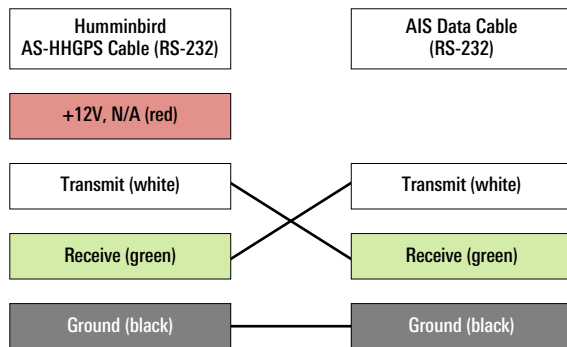

NOTE: It is important to correctly identify the transmit, receive, and ground wires on your AIS data cable regardless of the color. It is possible that the data cable does not follow color standards for RS-232 or RS-422.

Connecting an AIS to the HELIX Series with a Bare Wire Connection

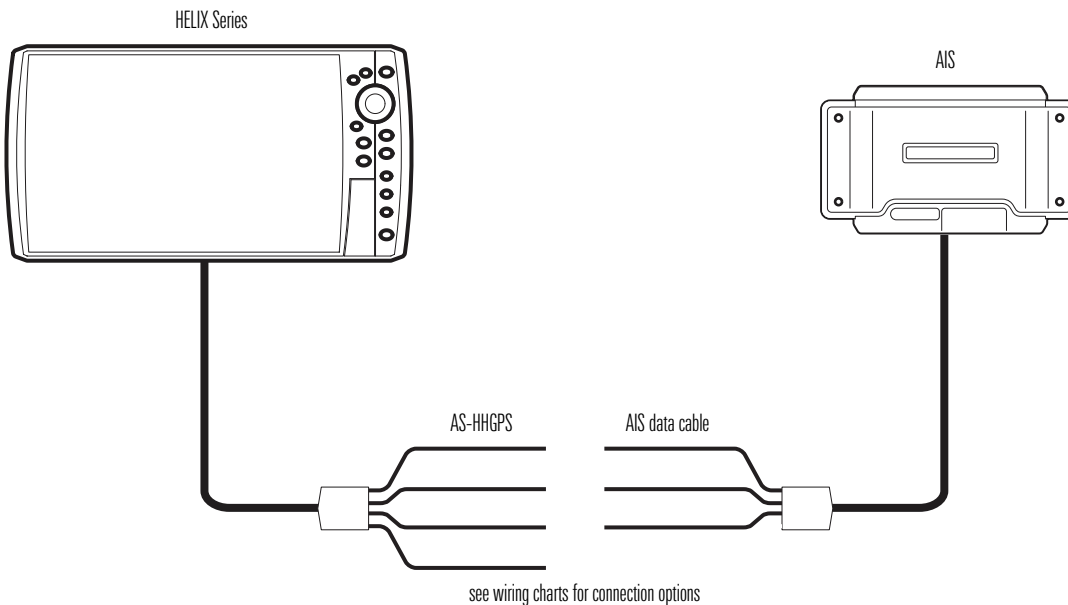

Chart 2 (Optional Wiring) RS-232 AS-HHGPS to RS-422 AIS

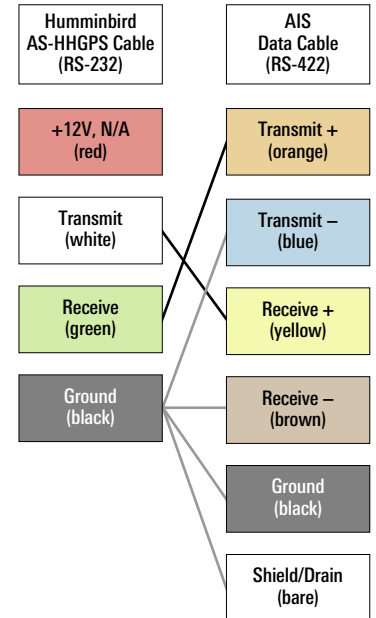

Chart 3 (Optional Wiring) RS-232 to RS-232

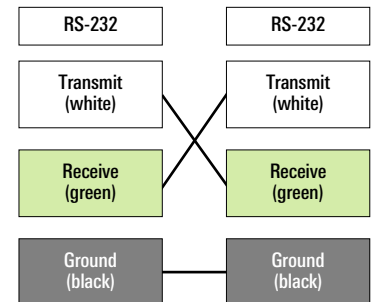
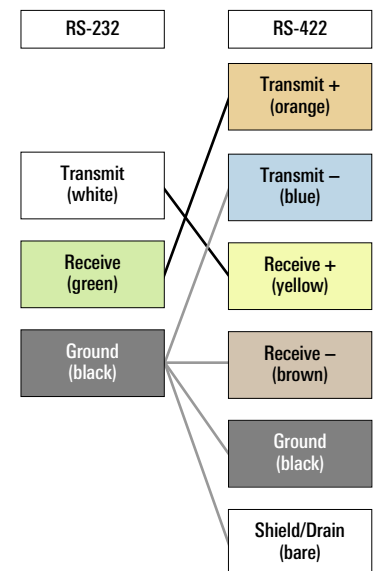

Chart 4 (Optional Wiring) RS-232 to RS-422



AIS Connection Guide

4. Tape or apply heat-shrink insulation to each connection to prevent shorting the wiring.
5. Tape or apply heat shrink insulation to the red wire on the AS-HHGPS Cable.
6. Route the cable to the Humminbird control head.
7. Connect the AS-HHGPS NMEA-COM connector to the Humminbird COM port.



NOTE: If your control head uses a cable collector or cable tray, see your control head installation guide for details.

8. Follow the instructions in the AIS manual to connect power to the AIS equipment and finish the installation.
9. Proceed to section 3 to set the baud rate.

3. Set the Baud Rate

Use the following instructions to configure the Humminbird control head and the AIS so they communicate at the same baud rate.

1. **Main Menu:** Press the Menu key twice.
2. Select the Setup tab > NMEA 0183 Output (or NMEA Output).
3. Select On or Off.

If NMEA 0183 output is not required for the Humminbird control head operation, turn off NMEA 0183 Output. When NMEA 0183 Output is turned off, baud rates 4800, 9600, and 38400 are available on the Humminbird control head.

If NMEA 0183 output is required for the Humminbird control head operation, turn on NMEA 0183 Output. When NMEA 0183 Output is turned on, the control head operates exclusively at 4800 baud rate.



NOTE: If the menu option is not shown under the Setup tab, make sure the User Mode is set to Advanced (Setup tab > User Mode > Advanced).

4. If you turned on NMEA 0183 Output, refer to your AIS installation guide to set the AIS baud rate to 4800.